

CFMN-2000BBC/7-DE-G

Specifications

Capacitance C_{max} (nominal)	2000 pF
Voltage (Peak Test U_{pt} / Peak Working U_{pw})	7 kV / 4.2 kV
Capacitance Tolerance	5%
Max. Current I_{max} at 13.56 MHz with	130 Arms
Conduction Cooling	50 W
Net Weight	0.7 kg

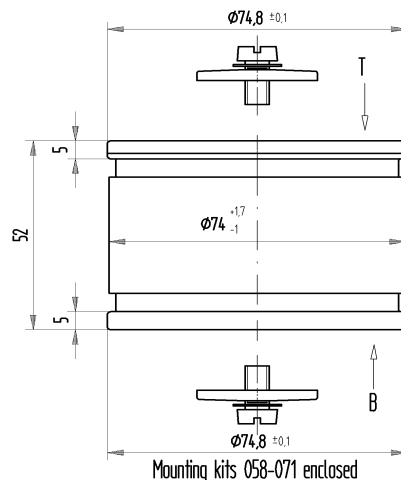

I_{max} at 25°C ambient and 125°C surface temp. for convection and conduction (50 W) cooling

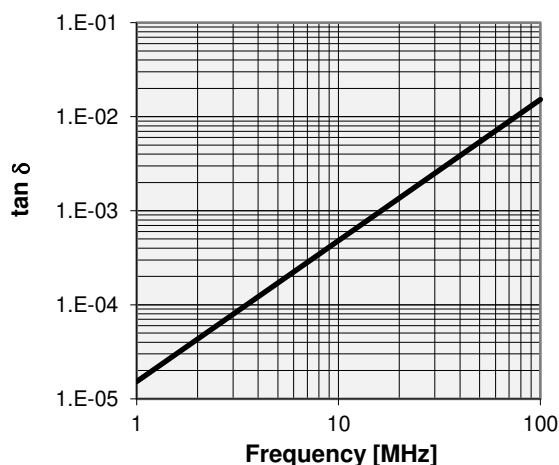
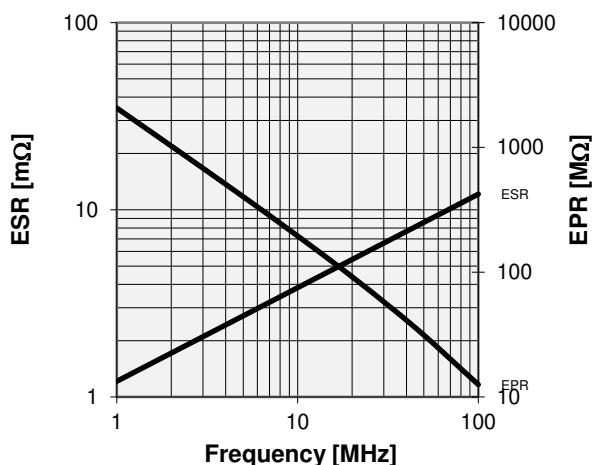
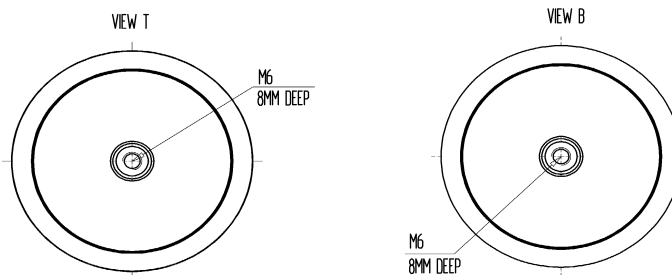
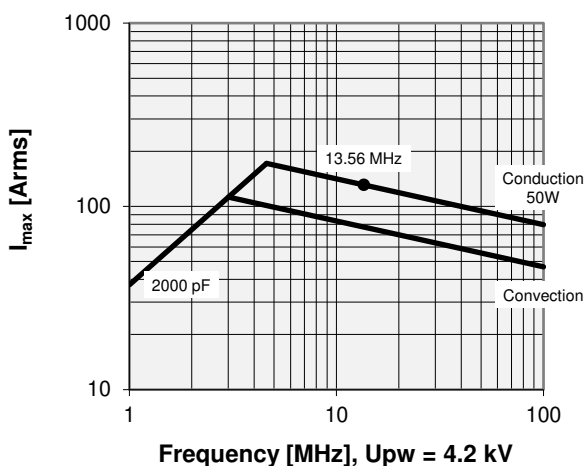

Special Features:
Capacity Tolerance 5%, RoHS Compliant

Note:
Technical information in Service Bulletin
SB-52 must be considered
Subject to change without prior notice