

CVMA-650AC/55-AAB-F

Old Type Designation: CV3C-650E

Specifications

Capacity C_{max} (nominal)	650 pF
Capacity C_{min} (nominal)	30 pF
Voltage (Peak Test U_{pt} / Peak Working U_{pw})	55 kV / 33 kV
Capacity Tolerance (linear Range)	3%
Max. Current I_{max} at 13.56 MHz	137 Arms
Self Inductance	≤ 24 nH
Capacitance per turn	11.1 pF/turn
Torque	≤ 1.5 Nm
Net Weight	8.6 kg

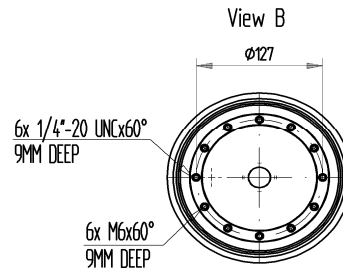
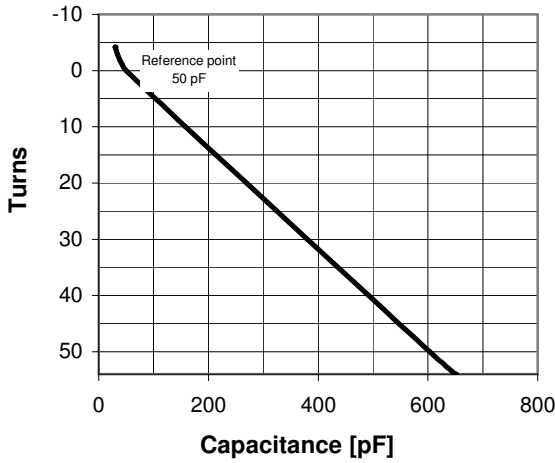
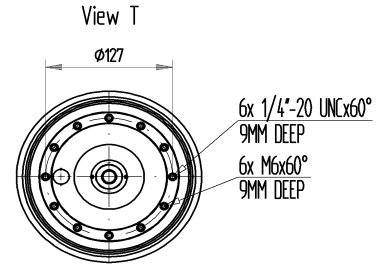

I_{max} at 25°C ambient and 125°C surface temp. for convection cooling

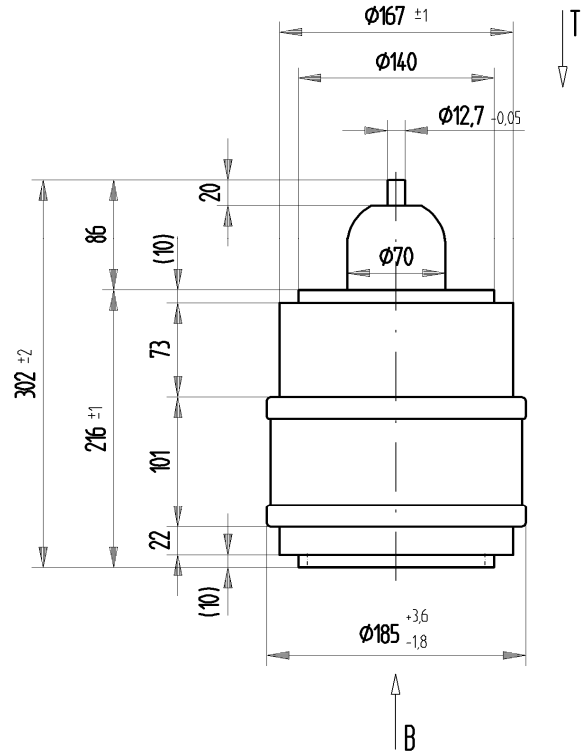
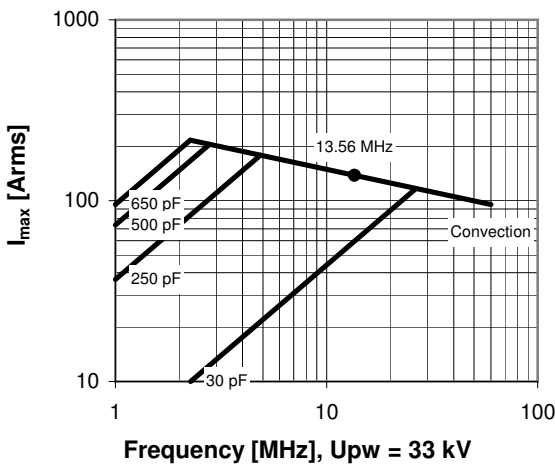

Turns	Nominal Capacitance [pF]	Tolerance
-4.2	30.0	3%
-4.0	30.4	3%
-3.0	33.7	3%
-2.0	37.9	3%
-1.0	43.2	3%
0.0	50.0	0%
10.0	157.9	3%
20.0	269.3	3%
30.0	380.6	3%
40.0	492.0	3%
50.0	603.3	3%
54.0	650.0	3%

Mechanical stop at < 30 pF at ~ -5.7 turns
Mechanical stop at > 650 pF at ~ 54.5 turns

Self inductance and resonance frequency

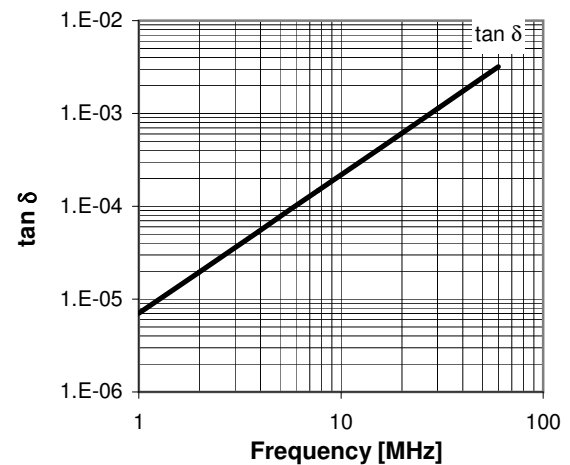
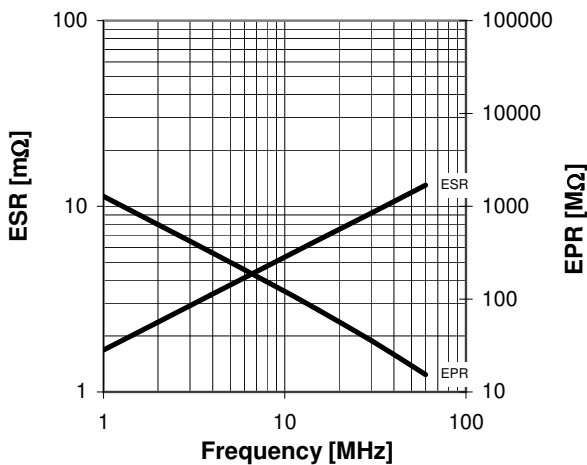
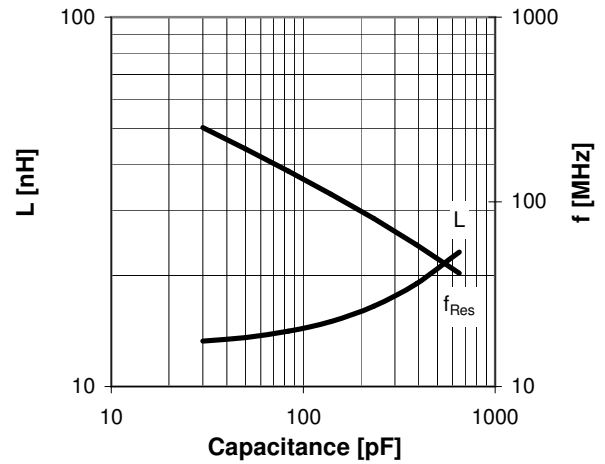

Special Features:

Capacity Tolerance 3%